

# INTERMERCATO® Forest residue grabs

HIGH PERFORMANCE LIFT & LOAD ATTACHMENTS

## TG SR

**Forest residue grab, ideal for feeding chippers**  
Available with 3, 4, 5 or 7 claws and is used for all sorts of wood waste. The larger models are so robust, they're suitable for rigid mounting on excavator.



# DEFINITELY A BEAST.





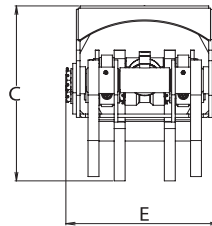
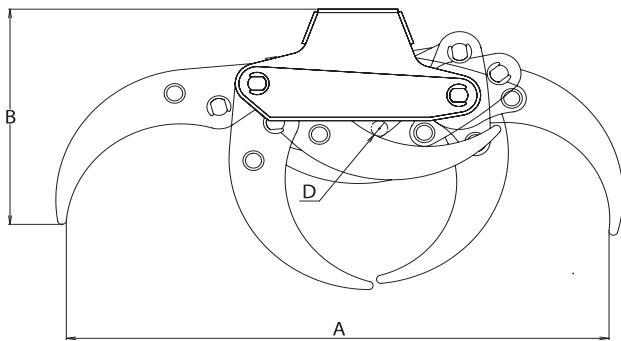





### KEY FEATURES

- Made of Hardox®
- Extra reinforced body for rigid mounting
- TG 28 SR and higher + the entire PRO-series have homogeneous guide bars made of Hardox®
- Optimal roll-in roll-out properties
- Cylinder with double piston rod seals for high pressure



	TG 12 SR5	TG 16 SR4-50	TG 16 SR4	TG 16 SR5	TG 16 PROSR4	TG 16 PROSR5	TG 16 PROSR7
<b>A</b>	810	952	950	933	950	950	950
<b>B</b>	550	550	550	590	482	482	482
<b>C</b>	350	420	417	400	355	355	355
<b>D</b>	38	60	60	60	47	47	50
<b>E</b>	273	301	301	287	344	344	344

	TG 22 PROSR4	TG 22 PROSR5	TG 25 SR3	TG 25 SR4-W	TG 25 PROSR4	TG 25 PROSR5	TG 28 SR3	TG 28 SR4	TG 28 SR5	TG 35 SR4	TG 35 SR5	TG 42 SR4	TG 42 SR5	TG 55 SR4	TG 55 SR5
<b>A</b>	1225	1225	1203	1460	1370	1370	1500	1500	1500	1890	1890	1895	1895	2425	2425
<b>B</b>	585	585	637	705	675	675	730	735	735	763	763	912	912	967	967
<b>C</b>	440	440	516	510	495	495	582	565	565	594	594	677	677	796	796
<b>D</b>	60	60	45	45	72	72	100	95	95	65	65	100	100	150	150
<b>E</b>	432	432	432	391	478	478	508	508	508	522	522	533	533	635	635

MODEL SPECS.											
TG 12 SR5	60	0,12	200	30	8	0,8	2,5	4	1-3	-	-
TG 16 SR4-50	67	0,16	200	40	16,7	1	3	5	1-3	-	-
TG 16 SR4	68	0,16	200	40	16,7	1	3	5	1-3	-	-
TG 16 SR5	75	0,16	200	40	16,7	1	3	5	1-3	-	-
TG 16 PRO SR4	78	0,16	200	40	7,25	2	4	7	1-6	1-4	Yes
TG 16 PRO SR5	81	0,16	200	40	7,25	2	4	7	1-6	1-4	Yes
TG 16 PRO SR7	88	0,16	200	40	7,25	2	4	7	1-6	1-4	Yes
TG 22 PRO SR4	150	0,20	200	50	11,6	3	5	10	4-10	4-6	Yes
TG 22 PRO SR5	156	0,20	200	50	11,6	3	5	10	4-10	4-6	Yes
TG 25 SR3	213	0,20	250	50	12,6	3	8	15	6-12	6-8	-
TG 25 SR4-W	230	0,25	250	50	12,6	3	8	15	6-12	6-8	-
TG 25 PRO SR4	217	0,22	250	50	14,5	4	10	15	6-12	6-10	Yes
TG 25 PRO SR5	230	0,22	250	50	14,5	4	10	15	6-12	6-10	Yes
TG 28 SR3	300	0,30	250	50	16,6	5	12	30	8-16	8-12	Yes
TG 28 SR4	295	0,30	250	50	16,6	5	12	30	8-16	8-12	Yes
TG 28 SR5	306	0,30	250	50	16,6	5	12	30	8-16	8-12	Yes
TG 35 SR4	380	0,38	250	60	17,2	7	15	35	10-20	10-14	Yes
TG 35 SR5	393	0,38	250	60	17,2	7	15	35	10-20	10-14	Yes
TG 42 SR4	458	0,50	250	60	21,8	8	20	40	12-22	12-16	Yes
TG 42 SR5	480	0,50	250	60	21,8	8	20	40	12-22	12-16	Yes
TG 55 SR4	873	0,65	250	70	24,2	10	30	-	14-25	14-18	-
TG 55 SR5	910	0,65	250	70	24,2	10	30	-	14-25	14-18	-

Recommended machine weight and crane size

## Accessorize your grab

### Crane scale

Intermercato is world leading in weighing of hanging load. Our crane scales are based on intelligent technology - an advanced algorithm calculates the weight.

### Rotator and excavator attachment

We can deliver all our grabs and clamshell buckets complete with rotator, excavator attachment and hose kit!



# INTERMERCATO®

High performance lift and load attachments for Forestry, Transport, Construction and Recycling.

