

INTERMERCATO®

HIGH PERFORMANCE LIFT & LOAD ATTACHMENTS

Universal grabs

GX

The original and bestseller from Intermercato

Our close to indestructible universal grab "cleaned up after the storm Gudrun" and has ever since been frequently copied. Intermercato GX is truly convincing with its extremely robust design and powerful claws. Can be equipped with a saw cassette.



KEY FEATURES







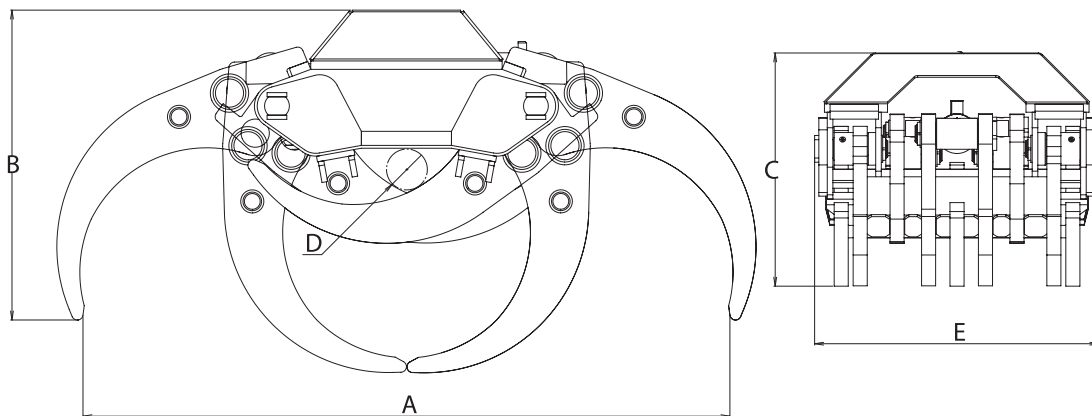



- Made of Hardox®
- Homogeneous guide bars made of Hardox®
- Extremely powerful claws
- Can be equipped with a saw cassette
- Optimal roll in- roll out properties
- Cylinder with double piston rod seals for high pressure

DEFINITELY A BEAST.

www.intermercato.com



	GX 22-30/5	GX 28-50/5	GX 28-50/7	GX 28- 50/1000	GX 36-50/5	GX 36-50/7	GX 55-50/5	GX 55-50/7
A	1056	1485	1471	1471	1800	1800	2295	2295
B	870	783	783	783	910	910	1100	1100
C	613	658	622	622	720	720	828	828
D	100	130	100	100	135	135	145	145
E	658	632	760	1000	658	1000	1010	1010

MODEL SPECS.	 Kg	 m²	 Bar	 l/min	 kN	 ton	 tm	 tm	 ton	 ton	
GX 22-30/5	405	0,22	250	60	17	4	-	-	6-12	6-10	-
GX 28-50/5	490	0,28	350	60	20	8	-	-	12-20	12-18	-
GX 28-50/7	557	0,28	350	60	20	8	-	-	12-20	12-18	-
GX 28-50/1000	575	0,28	350	60	20	8	-	-	12-20	12-18	-
GX 36-50/5	727	0,36	350	60	20,5	10	-	-	18-30	18-24	-
GX 36-50/7	860	0,36	350	60	20,5	10	-	-	18-30	18-24	-
GX 55-50/5	1660	0,50	350	70	50	12	-	-	22-45	22-32	-
GX 55-50/7	1805	0,50	350	70	50	12	-	-	22-45	22-32	-

Recommended machine weight and crane size

Accessorize your grab

Excavator attachment, rotator & scale

Accessorize your grab with an excavator attachment! We have suitable attachments for all types of excavators. We can also deliver all our grabs and clamshell buckets complete with hose kit!

Intermercato is world leading in weighing of hanging load. Our crane scales are based on intelligent technology - an advanced algorithm calculates the weight. It's the only RTT&E certified and legal for trade system in the world for hanging load in motion. Your success starts with Intermercato Intelligent Weighing Systems!

Accumulator, check valve and saw cassette

Can be equipped with accumulator from Parker and check valve. We can also deliver GX with saw cassette from Hultdins.



Intermercato is not only grapples - Explore our complete range of products on www.intermercato.com, or contact our proficient sales team.

INTERMERCATO®

High performance lift and load attachments for Forestry, Transport, Construction and Recycling.



www.intermercato.com | info@intermercato.com | Tel +46 (0)414 20525 | SE-272 93 Tommarp, Sweden